

尺寸 100*140mm

OMMO -English

Product Instructions Metal Detector for kids



Please charge the detector before using it for the first time. The indicator light flashes slowly while charging and stays on when the battery is fully charged.

Unterstützung
E-mail: service@ommohome.com

CE FC RoHS

English ----- 1-4
German ----- 5-8
French ----- 9-12
Spanish ----- 13-16
Italian ----- 17-20

Company name: YH Consulting Limited
Address: C/O YH Consulting Limited Office
147, Centurion House, London Road,
Slaines-upon-Thames, Surrey, London, TW18 4AX
Email: HZYHUK@gmail.com
Tel: +44 07514 477888

Firmenname: E-CrossStu GmbH
Adresse: Mainzer Landstr. 69,
Frankfurt am Main, 60529
Email: e-crossstu@outlook.com
Tel: +49 069332967674

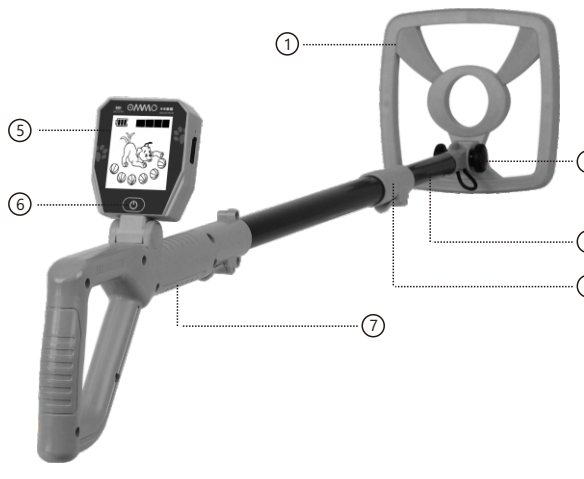

UK CE RoHS



Assembly Schematic:

3 parts Rotation lock Complete assembly and ready to use

Parameter:
Voltage: 4.2V
Current: 35mA (0.035A)
Power: 150mW (0.15W)
Frequency: 3KHZ

Note:
Press and hold the  button for 3 seconds to turn on or off, and short press the  button once to reset.

EASY TO USE AND UNDERSTAND

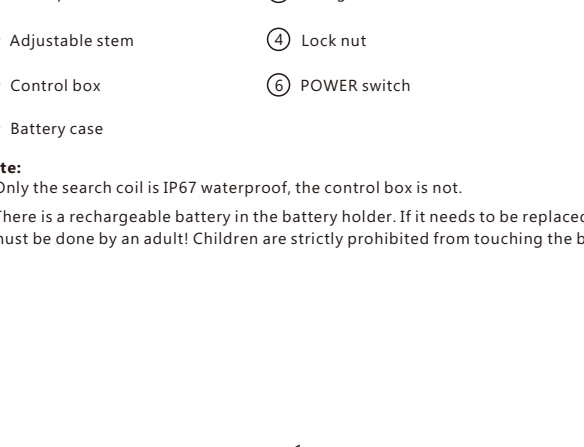

Note:
1. Only the search coil is IP67 waterproof, the control box is not.
2. There is a rechargeable battery in the battery holder. If it needs to be replaced, it must be done by an adult! Children are strictly prohibited from touching the battery!

Control Box



In standby mode, the balls will flash alternately.
In operating mode, the more targets there are, the closer the detector is to the targets and the stronger the signal.

Manually adjustable

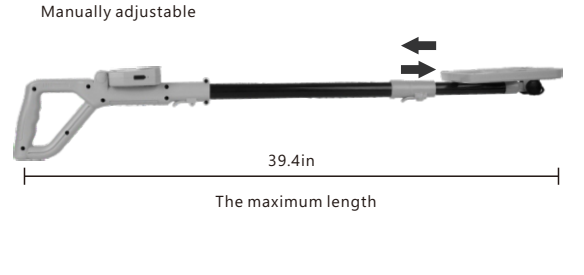

The maximum length: 39.4in

CONTACT INFORMATION
Website: www.ommohome.com
E-mail: service@ommohome.com

OMMO -German

Beschreibung der erzeugnisse Metalldetektoren für kinder



Bitte laden Sie das Detektor vor der erstmaligen Verwendung auf. Die Indikatorleuchte blinkt langsam während des Ladens und bleibt an, wenn die Batterie voll geladen ist.

Support
E-mail: service@ommohome.com

CE FC RoHS

German ----- 5-8
French ----- 9-12
Spanish ----- 13-16
Italian ----- 17-20



1. Wasserdichte Suchspule 2. Befestigungsknopf und Stecker
3. Verstellbarer Vorbau 4. Kontermutter
5. Steuerkasten 6. Stromschalter
7. Batteriegehäuse

Hinweis:
1. Nur der Suchspule ist IP67 wasserdicht, der Steuerkasten nicht.
2. Es befindet sich eine Ladungsbatterie im Batteriehalter. Wenn sie ersetzt werden muss, muss dies von einem Erwachsenen gemacht werden! Kindern ist es strengstens verboten, die Batterie zu berühren!

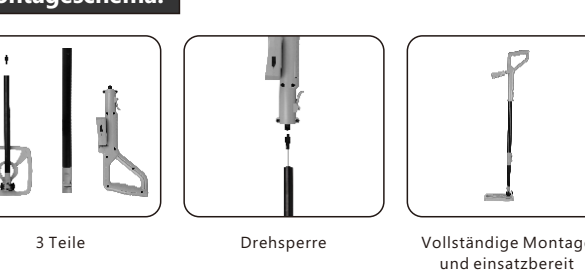
Montageschema:



Parameter:
Spannung: 4.2 V
Strom: 35mA (0.035A)
Leistung: 150mW (0.15W)
Frequenz: 3KHZ

Hinweis:
Halten Sie den  Knopf für 3 Sekunden gedrückt, um das Gerät einzuschalten oder auszuschalten, und drücken Sie kurz den  Knopf, um es zurückzusetzen.

EINFACH ZU VERWENDEN UND ZU VERSTEHEN

Manuell einstellbar

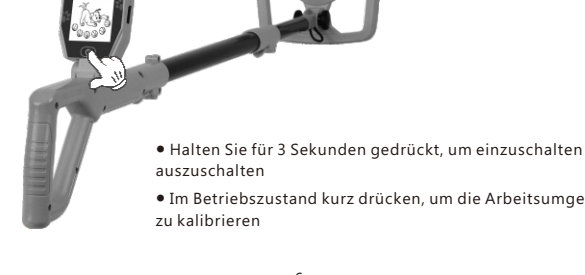

Die maximale Länge: 39.4in

Verstellbarer Vorbau



KONTAKTINFORMATIONEN
Website: www.ommohome.com
E-mail: service@ommohome.com

Verstellbarer Vorbau



KONTAKTINFORMATIONEN
Website: www.ommohome.com
E-mail: service@ommohome.com

OMMO -French

Mode d'emploi du produit Détecteur de métaux pour enfants



Veillez charger le détecteur avant de l'utiliser pour la première fois. La lumière indicatrice clignote lentement pendant le chargement et reste allumée lorsque la batterie est pleine.

Soutien
E-mail: service@ommohome.com

CE FC RoHS

French ----- 9-12
Spanish ----- 13-16
Italian ----- 17-20



1. Bobine de recherche étanche 2. Bouton de fixation et connecteur
3. Potence réglable 4. Contre-écrou
5. Boîtier de contrôle 6. Interrupteur d'Alimentation
7. Boîtier de la batterie

Remarque:
1. Se l'enrouleur de recherche est étanche IP67, le boîtier de contrôle ne l'est pas.
2. Il y a une batterie rechargeable dans le support de batterie. Si elle doit être remplacée, cela doit être fait par un adulte ! Les enfants sont strictement interdits de toucher la batterie !

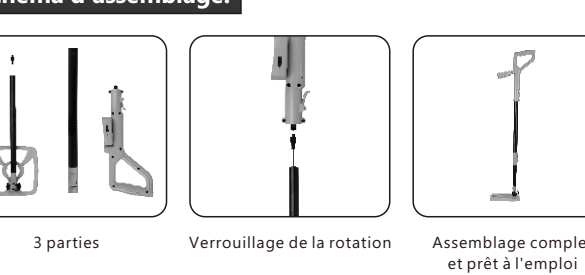
Schéma d'assemblage:



Paramètre:
Tension: 4.2 volts
Courant: 35mA (0.035A)
Puissance: 150mW (0.15W)
Fréquence: 3KHZ

Remarque:
Appuyez et maintenez le bouton  pendant 3 secondes pour allumer ou éteindre, et appuyez brièvement une fois sur le bouton  pour réinitialiser.

FACILE À UTILISER ET À COMPRENDRE

Régiable manuellement



La longueur maximale: 39.4in

Potence réglable



INFORMATIONS DE CONTACT
Site Web: www.ommohome.com
E-mail: service@ommohome.com

Potence réglable



INFORMATIONS DE CONTACT
Site Web: www.ommohome.com
E-mail: service@ommohome.com

OMMO -Spanish

Instrucciones del producto dector de metales para niños



Por favor, carga el detector antes de usarlo por primera vez. La luz indicadora parpadea lentamente mientras se carga y se mantiene encendida cuando la batería está completamente cargada.

Soporte
E-mail: service@ommohome.com

CE FC RoHS

Spanish ----- 13-16
Italian ----- 17-20



1. Bobina de búsqueda a prueba de agua 2. Perilla de fijación y conector
3. Vástago ajustable 4. Tuerca de bloqueo
5. Caja de control 6. Interruptor de ENCENDIDO
7. Carcasa de la batería

Nota:
1. Solo el bobinado de búsqueda es resistente al agua IP67, la caja de control no lo es.
2. Hay una batería recargable en el soporte de la batería. Si necesita ser reemplazada, debe ser hecho por un adulto! A los niños se les prohíbe estrictamente tocar la batería.

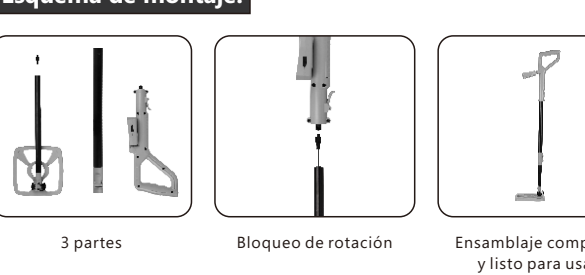
Esquema de montaje:



Parámetro:
Tensión: 4.2 V
Corriente: 35mA (0.035A)
Potencia: 150mW (0.15W)
Frecuencia: 3KHZ

Nota:
Mantén pulsado el botón  durante 3 segundos para encender o apagar, y pulsa brevemente el botón  para reiniciar.

FÁCIL DE USAR Y ENTENDER

Ajustable manualmente



La longitud máxima: 39.4in

Vástago ajustable



INFORMACION DEL CONTACTO
Sitio Web: www.ommohome.com
E-correo: service@ommohome.com

Vástago ajustable



INFORMACION DEL CONTACTO
Sitio Web: www.ommohome.com
E-correo: service@ommohome.com

OMMO -Italian

Istruzioni sul prodotto Metal Detector per bambini



Si prega di ricaricare il rilevatore prima di utilizzarlo per la prima volta. La luce indicativa lampeggia lentamente durante la ricarica e rimane accesa quando la batteria è completamente carica.

Supporto
E-mail: service@ommohome.com

CE FC RoHS

Italian ----- 17-20



1. Bobina di ricerca impermeabile 2. Manopola di fissaggio e connettore
3. Stelo regolabile 4. Dado di bloccaggio
5. Casella di controllo 6. Interruttore di ACCENSIONE
7. Custodia della batteria

Nota:
1. Solo il raggio di ricerca è resistente all'acqua IP67, la casella di controllo no.
2. C'è una batteria ricaricabile nel supporto della batteria. Se deve essere sostituita, deve essere fatto da un adulto! Ai bambini è severamente proibito toccare la batteria!

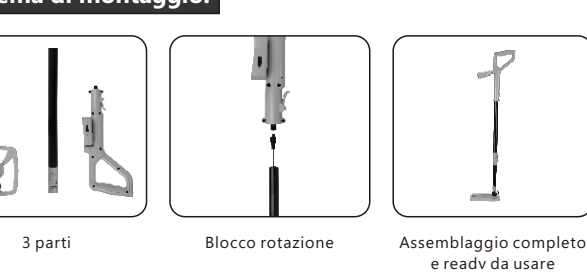
Schema di montaggio:



Parametro:
Tensione: 4.2 V
Corrente: 35mA (0.035A)
Potenza: 150mW (0.15W)
Frequenza: 3KHZ

Nota:
Premi e tieni premuto il pulsante  per 3 secondi per accendere o spegnere, e premi brevemente il pulsante  per resettare.

FACILE DA USARE E DA COMPRENDERE

Regolabile manualmente



La lunghezza massima: 39.4in

Stelo regolabile



INFORMAZIONISUICONTATTI
Sito web: www.ommohome.com
E-mail: service@ommohome.com

Stelo regolabile



INFORMAZIONISUICONTATTI
Sito web: www.ommohome.com
E-mail: service@ommohome.com